

Panasonic®

Color Video Projection System Operating Instructions

PT-65WX50

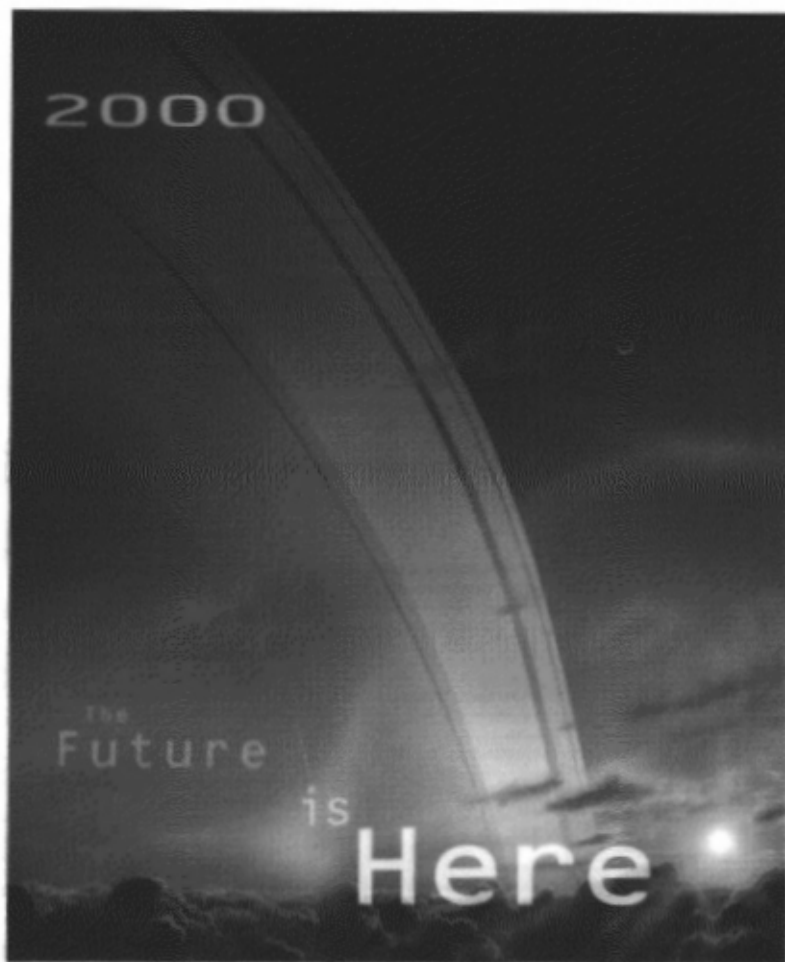

For assistance, please call: 1-800-211-PANA (7262) or
send e-mail to: consumerproducts@panasonic.com

TQB2AA0343 00508
PRINTED IN MEXICO

WARNING

To move set, push from left side of set. Casters on right side do not pivot in all directions. Set can tip over if moved from right side, with risk of personal injury.

ADVERTENCIA

Para mover el conjunto, empuje desde el lado izquierdo del mismo. Los rolanas de la derecha no son pivotantes en todas las direcciones. El conjunto se puede tumbar si se lo mueve desde el lado derecho, corriendo así el riesgo de sufrir daños personales.

Mise en garde

Lors du déplacement du téléviseur, le pousser sur son côté gauche. Les roulettes du côté droit ne pouvant tourner dans toutes les directions, l'appareil pourrait tomber s'il est poussé de ce côté et causer ainsi des risques de blessure.

警告

移動本機時，請從本機左側推動。推車右側不能旋轉。如從右側移動，則機體可能傾倒並造成傷害。

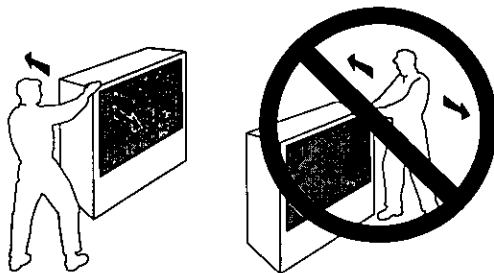

Certain audio features of this product manufactured under a license from Desper Products, Inc. Spatializer® and the circle-in-square device and trademarks owned by Desper Products, Inc. Spatializer U.S. Patents are: 4,308,423; 4,355,203 and 5,412,731.

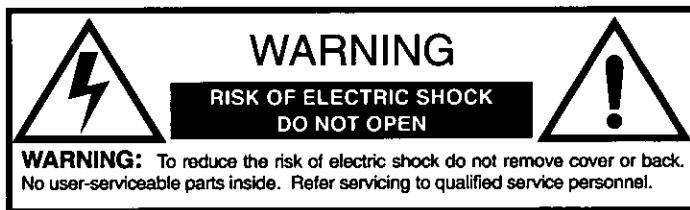

The lightning flash with arrow head within a triangle is intended to tell the user that parts inside the product are a risk of electric shock to persons.



The exclamation point within a triangle is intended to tell the user that important operating and servicing instructions are in the papers with the appliance.

WARNING: To prevent fire or shock hazard, do not expose this appliance to rain or moisture.

Parasonic Consumer Electronics Company,
Division of Mitsubishi
Electric Corporation of America
One Parasonic Way
Secaucus, New Jersey 07094
www.parasonic.com
(800) 222-4213

Table of Contents

Congratulations 3
 Customer Record3
 Care and Cleaning3
 Specifications3
Installation..... 4
 Television Location.....4
 Optional Cable Connections.....4
 AC Power Supply Cord4
 Cable / Antenna Connections4
Optional Equipment Connections..... 5
 VCR Connection.....5
 Front A/V Input Jacks6
 Cable Box Connection.....6
 VCR and Cable Box Connection7
 Amplifier Connection (To Audio Amp)8
 Program Out Connection (PROG. OUT)8
Digital TV Set-Top Box (DTV-STB) Connection 9
Home Theater Connection..... 10
Split Screen Operation..... 11
 Without a VCR11
 With a VCR and Cable Box11
 With a VCR - No Cable Box11
Remote Control..... 12
Quick Reference Functional Key Chart..... 13
Programming The Remote..... 16
Component Codes..... 17
Roller Guide Menu..... 21
 Basic Navigation.....21
Roller Guide Menu Chart 22
Special Features 25
 Menu Languages.....25
 Channel Programming25
 Closed Captioning26
 Convergence Adjustment27
 Sleep Timer28
 Timer 1 and 228
 Picture Adjustments29
 Audio Adjustments29
 Favorite Channels and Captions30
 Lock.....31
Troubleshooting Chart..... 32

Read these instructions completely before operating TV.

Contents are subject to change without notice or obligation.

Copyright 2000 by Matsushita Electric Corporation of America. All rights reserved.
Unauthorized copying and distribution is a violation of law.

Congratulations

Your new Projection Television (PTV) features state-of-the-art technology for high-quality picture and sound with complete audio/video connections for your home theater system. Standard television signals are displayed in a progressive scan format, providing a clear, crisp picture without visible scan lines. This PTV is also DTV (Digital TV) compatible. When connected to a Panasonic digital TV set-top box, this TV can display high-definition (HDTV) 1080i and 720p formats and standard definition (SDTV) 480p format. Your new PTV is designed to give you many years of enjoyment. It was thoroughly tuned and tested at the factory for best performance.

Customer Record

The model and serial number of this product are located on the back of the TV. You should note the model and serial number in the space provided and retain as a permanent record of your purchase. This will aid in identification in the event of theft or loss. Product registration is available at: www.prodreg.com/panasonic.

Model	
Number	
Serial	
Number	

Care and Cleaning

Protective Screen (Turn PTV Off)

The projection screen is a precision lens system and has a protective screen. The protective screen is fully washable with the following precautions:

- Use a mild soap solution or window cleaner and a clean cloth.
 - DO NOT USE ABRASIVE CLEANERS.
 - Do not use laundry detergent or automatic dishwasher soap.
 - Do not use alcohol, ammonia, or petroleum based products.
- Avoid excessive moisture and wipe dry.
 - Prevent solution from running into the receiver below.
- Avoid bumping or scraping the screen.

Cabinet and Remote Control

- For cabinets and Remote Control, use a soft cloth dampened with water or a mild detergent solution. Avoid excessive moisture and wipe dry.
- Do not use benzene, thinner or other petroleum based products.

Specifications

Power Source PT-65WX50 (4.4A)	120V AC, 60Hz
Channel Capability - 181	VHF-12; UHF-56; Cable-125
4 Video Input	1Vp-p, 75 Ohm, Phono Jack Type
6 Audio Input (2 Component)	500mV RMS 47K Ohm
1 S-Video Output Jack	1Vp-p, 75 Ohm, Phono Jack Type
1 Audio Output	0-2.0V RMS 4.7K Ohm
4 S-Video Jacks (3 inputs & 1 output)	S-Video (Y-C) Connector
2 Component Video Inputs (Y, P_B, P_R)	75 Ohm, Phono Jack Type

Specifications are subject to change without notice or obligation.

Television Location

This unit can be used as part of an entertainment center. Consult your dealer for available options.

- Avoid excessive sunlight or bright lights, including reflections.
- Keep away from excessive heat or moisture. Inadequate ventilation may cause internal component failure.
- Fluorescent lighting may reduce remote control transmitting range.
- Keep away from magnetic equipment, including motors, fans, or external speakers.

Optional Cable Connections

Shielded audio and video cables should be used between components. For best results:

- Use 75-ohm coaxial shielded cables.
- Use appropriate input and output connectors that match your component connectors.
- Avoid long cables to minimize interference.

AC Power Supply Cord

CAUTION: TO PREVENT ELECTRIC SHOCK, MATCH WIDE BLADE OF PLUG TO WIDE SLOT OF AC OUTLET AND FULLY INSERT. DO NOT USE A PLUG WITH A RECEPTACLE OR OTHER OUTLET UNLESS THE BLADE CAN BE FULLY INSERTED TO PREVENT BLADE EXPOSURE.

Polarized Plug



Cable / Antenna Connections

For proper reception, either a cable or antenna connection is required.

Cable Connection

Connect the cable supplied by your local cable company to ANT1 connection on back of television. Select cable mode and ANT1 in SET UP menu under Prog Chan (Program Channels).

Note: A cable converter box may be required for proper reception. Check with your local cable company for compatibility requirements.

Incoming Cable from Cable Company



75 Ohm VHF/UHF on back of TV

Antenna Connection

- For proper reception of VHF/UHF channels, an external antenna is required. For best reception, an outdoor antenna is recommended.
- Connect home antenna to back of television. Select TV mode and ANT1 in the SET UP Menu under Prog Chan.

 Cable Preset
Cable Mode is preset at the factory. Antenna users must change to TV Mode and ANT1 in the Set Up Menu under Prog Chan.

Incoming Cable from Home Antenna

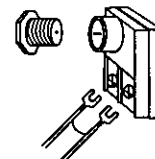

Optional Equipment Connections

VCR Connection

Follow this diagram when connecting your television to a VCR only.

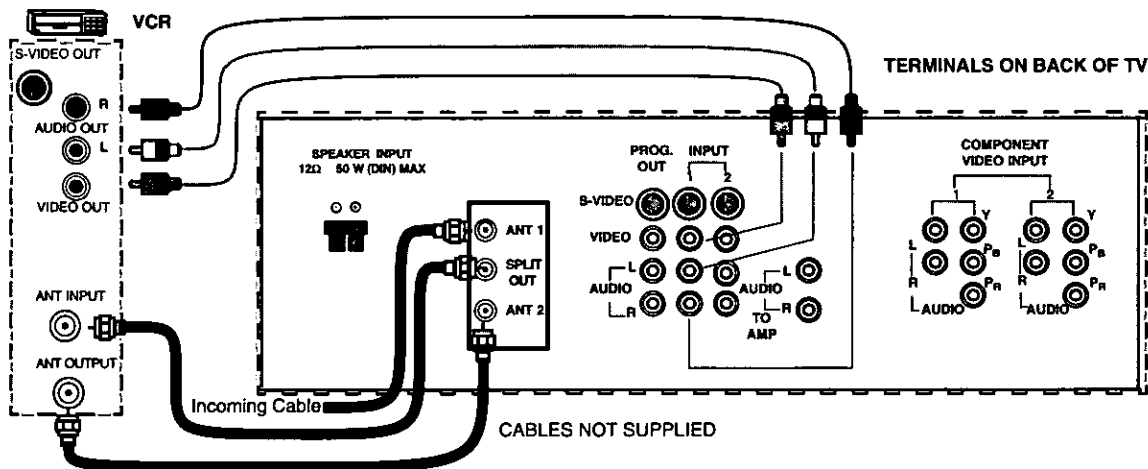

Note: The remote control must be programmed with supplied codes to operate the VCR. See *Programming the Remote Control* in this manual.

Viewing a television program

Procedure

1. Select ANT1 in the SET UP menu under Prog Chan (Program Channels).
2. Tune the television to the television program you want to view.

Viewing a video cassette tape

Procedure

- Option A
 1. Select ANT1 in the SET UP menu under Prog Chan (Program Channels).
 2. Press the **TV/VIDEO** button on the remote control to select the video input (VIDEO 1, VIDEO 2, etc.) connected to your VCR.
 3. Begin the video.
- Option B
 1. Select ANT2 in the SET UP menu under Prog Chan (Program Channels).
 2. Tune the television to Channel 3 or 4, depending on your VCR.
 3. Begin the video.

Note: The S-VIDEO connection is optional and overrides other VIDEO connection.

Recording a television program

Procedure

- Option A (Recording and viewing the same program)
 1. Select ANT2 in the SET UP menu under Prog Chan (Program Channels).
 2. Tune the television to Channel 3 or 4, depending on your VCR.
 3. Using the VCR, tune to the television program you want to record.
 4. Begin recording.
- Option B (Recording one program while viewing another program)
 1. Select ANT1 in the SET UP menu under Prog Chan (Program Channels).
 2. Press the **TV/VIDEO** button on the remote control to select the video input (VIDEO 1, VIDEO 2, etc.) connected to your VCR.
 3. Using the VCR, tune to the television program you want to record.
 4. Begin recording.
 5. Press the **TV/VIDEO** button on the remote control to switch back to regular television.
 6. Tune the television to the television program you want to view.

Optional Equipment Connections (Cont.)**Front A/V Input Jacks**

Open the door on the PTV front panel to use the terminals for your optional equipment. Press the **TV/VIDEO** button to select VIDEO 3 input mode.

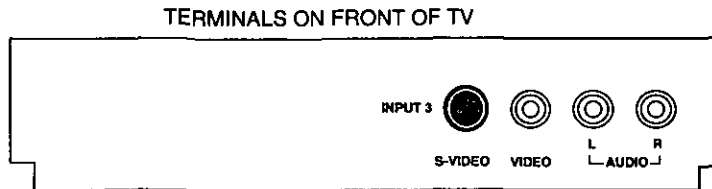

Note: A second VCR, a video disc player, video game equipment and DSS equipment can also be connected to the video inputs. See the optional equipment manual for details.

Cable Box Connection

Follow this diagram when connecting your PTV to a cable box only.

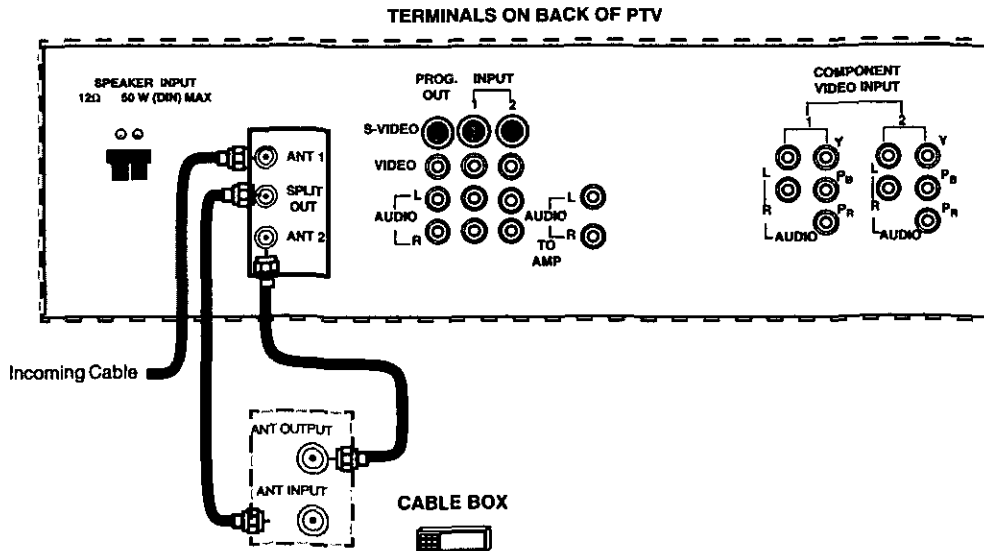

Note: The remote control must be programmed with supplied codes to operate the cable box. See *Programming the Remote Control* in this manual.

Viewing a premium (scrambled) cable channel**Procedure**

1. Select ANT2 in the SET UP menu under Prog Chan (Program Channels).
2. Tune the television to Channel 3.
3. Using the cable box, tune to the premium (scrambled) cable channel you want to view.

Note: To use special features such as Favorite Channels and Channel Captions (see *Special Features* section for more information), ANT1 must be selected in the SET UP menu under Prog Chan (Program Channels).

Optional Equipment Connections (Cont.)

VCR and Cable Box Connection

Follow this diagram when connecting your television to both a VCR and a cable box.

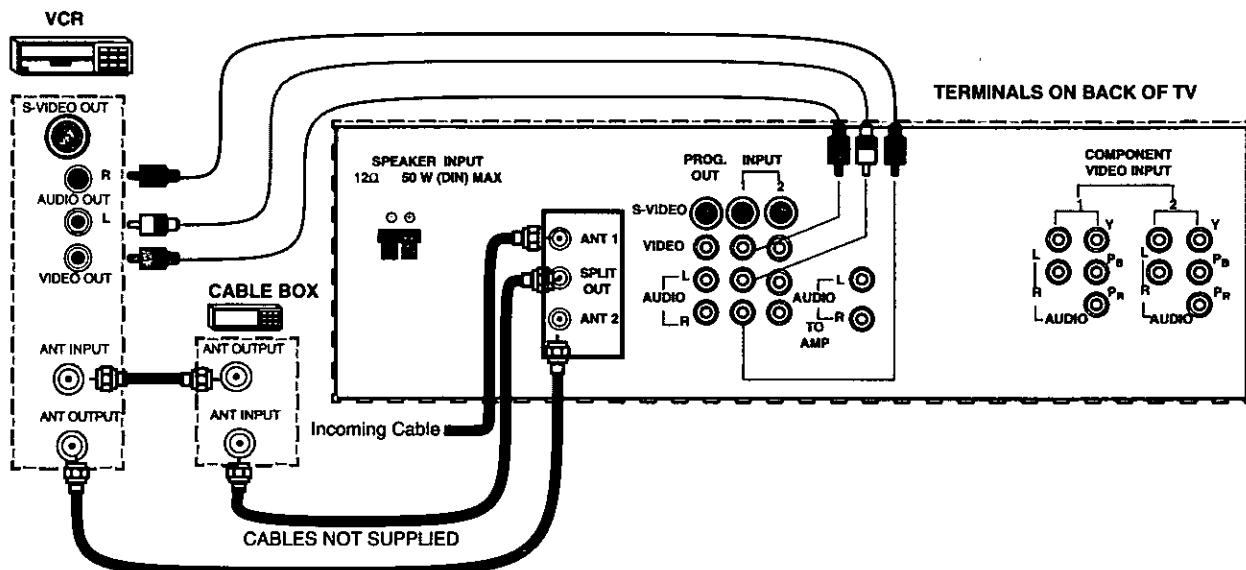

Note: The remote control must be programmed with supplied codes to operate the VCR and cable box. See *Programming the Remote Control* in this manual.

Viewing a premium (scrambled) cable channel

Procedure

1. Select ANT2 in the SET UP menu under Prog Chan (Program Channels).
2. Tune the television to Channel 3.
3. Using the cable box, tune to the premium (scrambled) cable channel you want to view.

Note: To use special features such as *Favorite Channels* and *Channel Captions* (see *Special Features* section for more information), ANT1 must be selected in the SET UP menu under Prog Chan (Program Channels).

Recording a premium (scrambled) cable channel

Procedure

1. Select ANT2 in the SET UP menu under Prog Chan (Program Channels).
2. Press the **TV/VIDEO** button on the remote control to select the input (VIDEO 1, VIDEO 2, etc.) connected to your VCR.
3. Turn the VCR ON.
4. Tune the VCR to Channel 3 or 4, depending on your VCR.
5. Using your cable box, tune to the premium (scrambled) cable channel you want to record.
6. Begin recording.

Note: To view a different channel while recording:

- Select ANT1 in the SET UP menu under Prog Chan (Program Channel).
- Press the **TV/VIDEO** button on the remote control to select TV mode.
- Tune the television to a television program (except another premium (scrambled) cable channel).

Optional Equipment Connections (Cont.)

Amplifier Connection (TO AUDIO AMP)

Connect to an external audio amplifier input for listening through a stereo system.

Note: TO AUDIO AMP terminals cannot be connected directly to external speakers.

Audio Adjustments

1. Select SPEAKERS ON located in the on screen AUDIO menu.
2. Set amplifier volume to minimum.
3. Adjust TV volume to desired level.
4. Adjust amplifier volume to match the TV.
5. Select SPEAKERS OFF & VARIABLE AUDIO OUT from AUDIO menu.
6. Volume, mute, bass, treble and balance are now controlled through the television.

Note: Select SPEAKERS OFF & Fixed Audio Out to control audio functions through the external amplifier.

Program Out Connection (PROG. OUT)

For monitoring the television audio and video with optional video equipment, connect to PROG. OUT terminals on the back of the TV.

Procedure

1. Connect optional video equipment to PROG. OUT video and TO AUDIO AMP R/L Audio terminals.
2. PROG OUT terminal display is the same as the on screen display.
3. See optional equipment manual for further instructions for recording or monitoring.

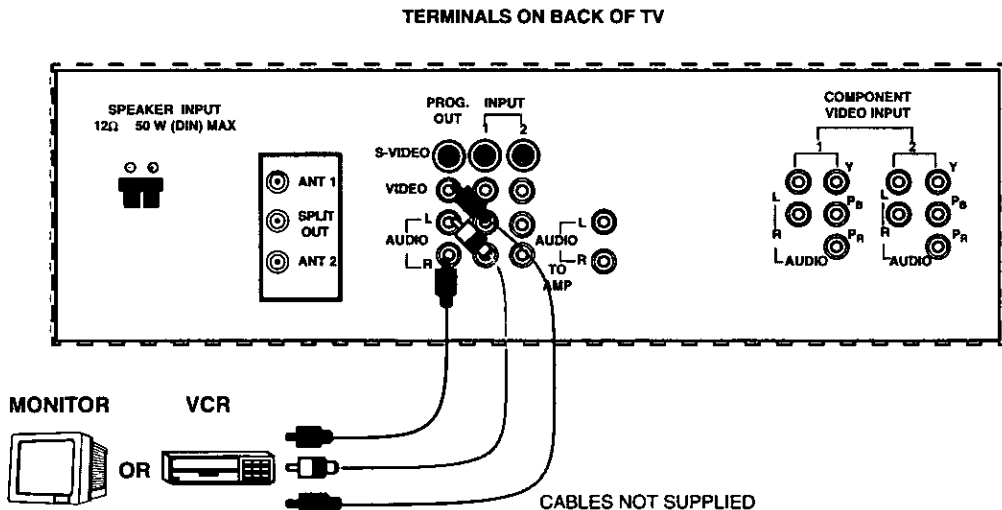

Digital TV Set-Top Box (DTV-STB) Connection

Use this diagram to connect the Panasonic DTV-STB (Digital TV-Set-Top Box) to the back of your TV.

DTV TERMINALS ON BACK OF TV

DTV TERMINALS ON BACK OF DTV-STB

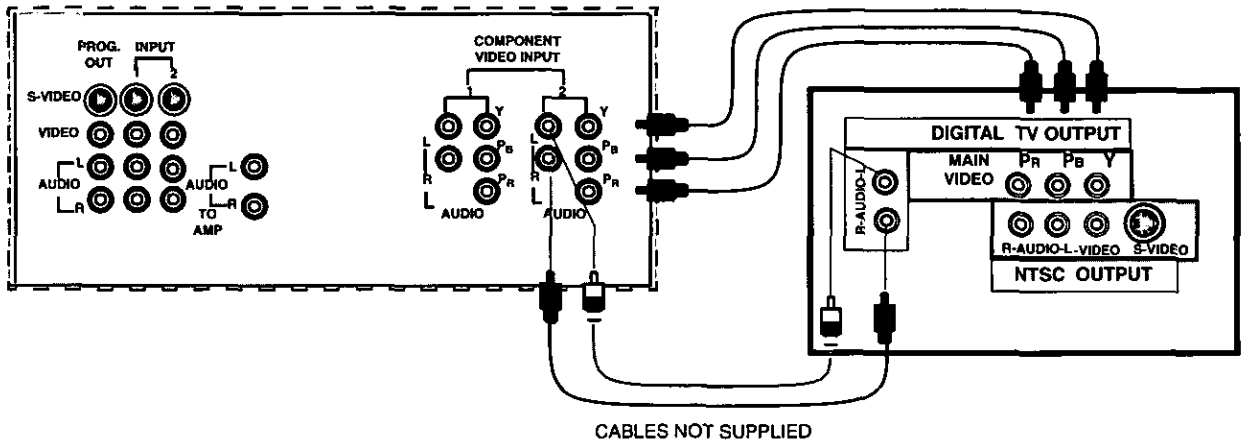

Note: There are two sets of component video inputs. Each has three video inputs, Y, P_B and P_R. Separate component color inputs provide luminance and color separation. Use component audio input 1 or 2 L (left) and R (right) for connecting to audio output of Panasonic DTV-STB.

Home Theater Connection

Your TV can be configured to use the TV speakers as center channel speakers in Dolby* surround sound transmission. Connect a Dolby surround sound amplifier to CENTER CHANNEL INPUT on the back of the TV, as shown. EXT & FAO must be selected in the AUDIO Roller Guide™™™ Menu under SPEAKERS.

**U.S. Patent Pending

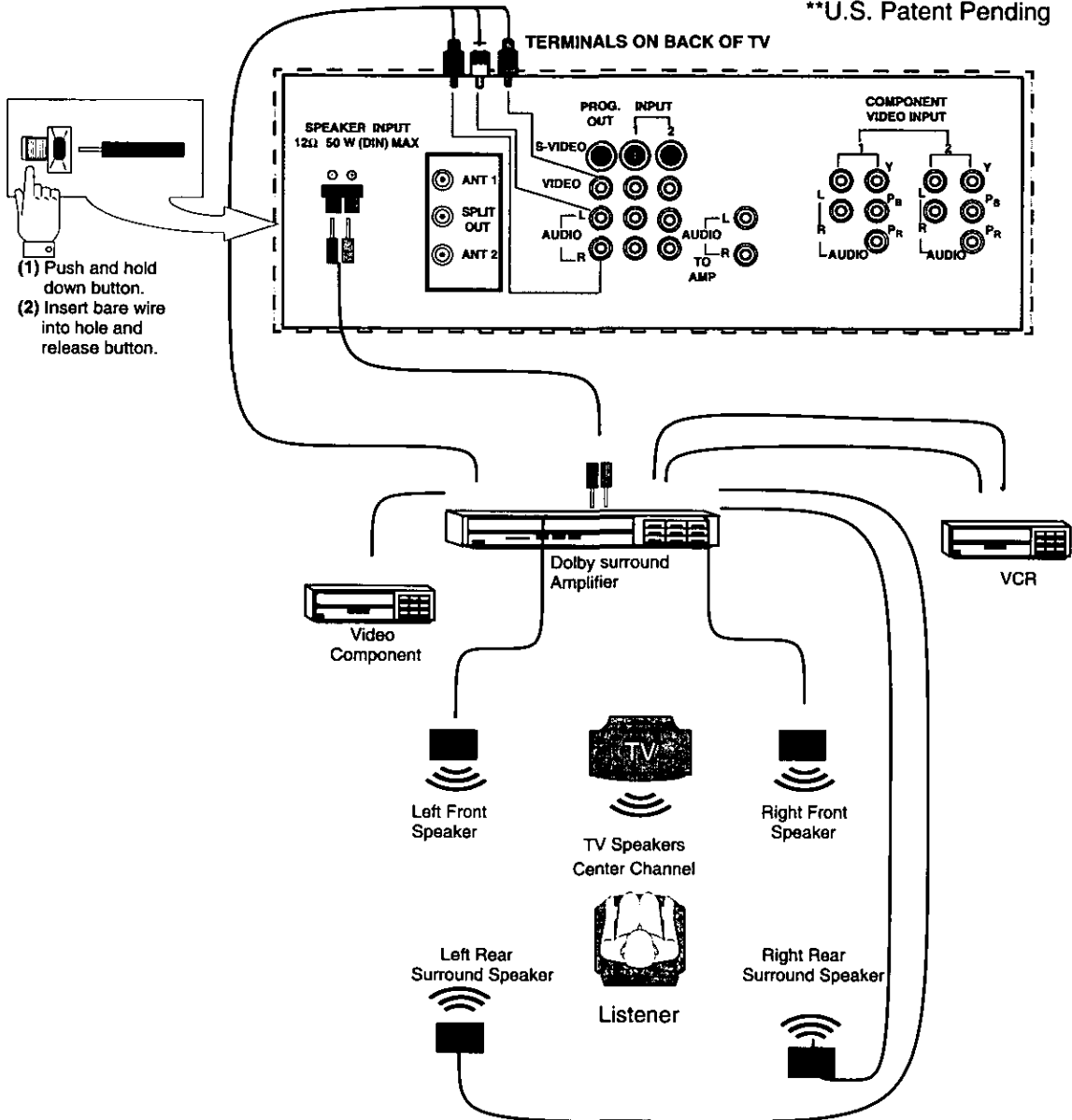

*Manufactured under license from Dolby Laboratories. "Dolby", "AC-3", "Pro Logic" and the double-D symbol are trademarks of Dolby Laboratories.

Split Screen Operation

This television includes a two tuner split screen feature. This allows watching two (2) live broadcasts at the same time with or without an external video source (VCR).

Note: *The Remote Control must be programmed with supplied codes to operate the VCR and Cable Box. See Programming the Remote Control in this manual.*

Without a VCR

Procedure

- Connect incoming cable to antenna (ANT 1) input on back of TV.
- Press the **SPLIT**  button on the Remote Control to display the Split Screen.

Note: *The audio is for the Main Picture, only.*

- Choose channels for the *Split Screen Picture* by pressing the Remote Control **SPLIT CHANNEL** up/down buttons.
- Choose channels for the *Main Picture* by pressing the Remote Control **CH** up/down buttons or by using the numeric keypad.

With a VCR and Cable Box

Procedure

Press the **SPLIT**  button on the Remote Control to display the Split Screen.

Note: *The audio is for the Main Picture only.*

To view scrambled channels through your Cable Box on the Split Screen:

- Verify the Cable Box and VCR are ON and the VCR tuned to Channel 3 or 4, depending on the VCR.
- Press the **TV/VIDEO** button on the Remote Control to select the video input for your VCR.
- Press **CBL** button on the Remote Control to select cable box.
- Choose channels for the *Split Screen* by pressing the **SPLIT CHANNEL** up/down buttons on the Remote Control or by using the numeric keypad.
- Choose channels for the *Main Picture* by pressing the **TV** button on the Remote Control and using the numeric keypad or **CH** up/down buttons.

With a VCR- No Cable Box

Procedure

Press the **SPLIT**  button on the Remote Control to display the Split Screen.

Note: *The audio is for the Main Picture, only.*

To view an external video source in the Split Screen:

- Press the **TV/VIDEO** button on the Remote Control to select the video input for your VCR.
- Verify the VCR is on.
- Insert a tape into the VCR and push Play button to watch the video in the *Split Screen*.
- Choose channels for the *Main Picture* by pressing the **TV** button on the Remote Control and using the numeric keypad or **CH** up/down button.

Note: *The **SWAP** button switches the Split Screen and Main Picture source. Press the **RECALL** button for Split Screen status, onscreen.*

Remote Control

POWER
Press to turn ON and OFF.

MUTE
Press to mute sound. Press to access and cancel CC (Closed Caption) and CC On Mute.

ACTION
Press to access menus.

CH
Press to select next channel and navigate in menus.

***R-TUNE**
Press to switch to previously viewed channel or video mode.

EXIT/GUIDE
DBS function buttons.

REW, PLAY, FF, TV/VCR, STOP, PAUSE, REC, VCR CHANNEL
Component function buttons.

OPEN/CLOSE, SLOW, STILL
DVD functions buttons.

SEARCH, SPLIT, FREEZE, SPLIT CHANNEL, SWAP
SPLIT function buttons.

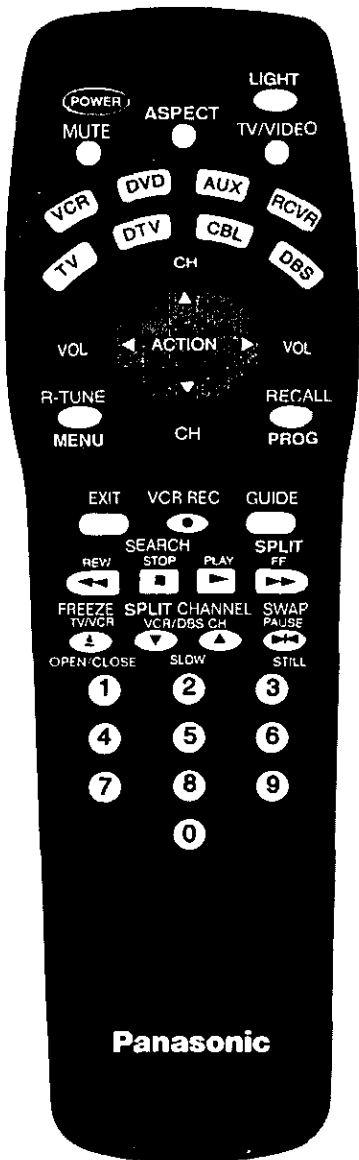

ASPECT
Select picture size (wide) through programming menu.

TV/VIDEO
Press to select TV or video mode.

VCR, DVD(LD/CD)☆, AUX, RCVR, TV, DTV, CBL, DBS, RCVR
Press to select related function.

VOL
Press to adjust TV sound and navigate in menus.

***RECALL**
Press to display the stored sleep timer and power on timer.

MENU/PROG
Optional buttons for use with Set-Top Box.









"0" - "9"
Press numeric keypad to control Channel.

EUR511165





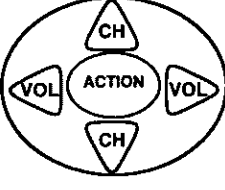

*To prolong the life of the batteries, turn the light off and on by pressing R-TUNE and RECALL buttons, simultaneously.





☆To Control CD, LD or DVD player, press DVD button first.

Quick Reference Functional Key Chart

Key	Operates	Function
	All Components [☆]	Turns On and Off selected components
LIGHT 	Remote Control	Illuminate buttons
MUTE 	TV CABLE	Mutes TV audio
ASPECT 	DTV TV	Select picture size (ratio) to match programming format
TV/VIDEO 	TV RCVR	Selects the input mode
	All Components	Component mode selection for remote control
	TV CBL VCR CH △	Channel Up/Down
	DBS RCVR DBS DTV ▽ CH	Navigation Up/Down
	LD	Next/Previous Chapter
	CD	Next/Previous Track
	TV CBL VCR LD CD RCVR AUX VOL ◀ ▶ VOL	Volume (+/-)
	DBS DVD DTV	Navigation Left/Right
	TV	Roller Guide Menu
	VCR	Menu
	CABLE	Enter
	DBS	DBS Menu
	DVD	Select
R-TUNE  MENU	TV CABLE DBS	Previous Channel
	DVD	DVD Menu
	AUX (Cassette Deck)	Deck A/B
	DTV	Menu On/Off

QUICK REFERENCE FUNCTIONAL KEY CHART

Key	Operates	Function
RECALL  PROG	TV VCR CBL DBS DVD LD CD DTV	Onscreen Display Time Format Set-Top Box Program
① ② ③ ④ ⑤ ⑥ ⑦ ⑧ ⑨ ⑩	TV VCR CABLE DBS All Components CD RCVR	Selects Channel Selects Code Selects Track Keys 1,2,3 and 4 select A/V inputs; 5 Cd; 6 Tuner; 7 Phono; 8 Cassette Deck; 9 Aux
EXIT 	DBS	Exit Menus
GUIDE 	DBS DVD LD CD	DBS Guide Title Repeat AB Next Disc
PLAY 	VCR DVD CD AUX (Cassette Deck)	Play
SPLIT FF 	TV VCR AUX (Cassette Deck) DVD LD CD RCVR	SPLIT On/Off Fast Forward Skip Search Fast Forward Search Fast Forward Surround (+)
REW 	VCR AUX (Cassette Deck) DVD CD RCVR	Rewind Skip Search Fast Rewind Search fast Rewind Surround (-)
SEARCH STOP 	TV VCR DVD CD LD AUX (Cassette Deck)	SPLIT Search Stop

Key	Operates	Function
VCR REC 	VCR DBS AUX (Cassette Deck)	Record
FREEZE TV/VCR  OPEN/CLOSE	TV VCR DVD CD LD AUX (Cassette Deck)	SPLIT Freeze TV/VCR Switch Open/Close
SWAP PAUSE  STILL	TV VCR CD LD AUX (Cassette Deck) DVD	SPLIT Swap Pause Still
SPLIT CHANNEL VCR /DBS CH  SLOW	TV VCR DVD DBS CD RCVR	SPLIT Channel Channel Up/Down Channel Up/Down (slow +/-) Page Up/Down Repeat (+) - Random (-) Center Channel (+/-)

Battery Installation

Use two AA batteries:

Remove battery cover by pushing in and up near arrow.

Install batteries matching (+) and (-) polarity signs.

Replace the battery cover.

Precautions

- Replace batteries in pairs.
- Do not mix battery types (zinc carbon with alkaline).
- Do not recharge, heat, short-circuit, disassemble, or burn batteries.

Incorrect installation can cause battery leakage and corrosion that will damage the Remote Control.

Programming The Remote

The Universal Remote Control can be programmed to operate many manufacturers' components, using the component function buttons for VCR, DVD, AUX, TV, CABLE, DBS or RCVR. Follow the procedures for programming your Remote Control with or without a code for the component.

Determine the manufacturer of the component and look in the table for the code.

WITH A CODE

- Confirm that the external component is plugged in and on.
- Turn the component off.
- Press the **ACTION** and **POWER** button, together, for at least 5 seconds.
- Press appropriate component button on the Remote Control. (VCR, DVD, AUX, TV, CABLE, DBS or RCVR)
- Enter the 3-digit component code using the Remote Control numeric keypad (0 ~ 9 buttons).
- Press the Remote Control **POWER** button to test the component. If the procedure was successful, the component will turn on.



Helpful Hints: Unsuccessful Code

If the component does not operate with the Remote Control, repeat the procedure using another code. (Some brands have multiple codes.)

If an incorrect code is entered, or if the procedure takes longer than 30 seconds, the programming will fail.

WITHOUT A CODE

This procedure searches all codes and is called the "sequence method".

- Confirm that the external component is plugged in and on.
- Turn the component off.
- Press the **ACTION** and **POWER** button, together, for at least 5 seconds.
- Press appropriate component button on the Remote Control.
- Press the  button to move forward to the next code. Press the  button to move backward.
- Press the Remote Control **POWER** button to test the component. If the procedure was successful, the component will turn on.

Note: Repeat the above steps until the component code is found. It may take many attempts before the correct code is found.

- After the code is found, press the **ACTION** button to store the code.

Write the code numbers from tables in this space. This will serve as a reference if you need to program your Remote Control.

CABLE BOX	DVD	VCR	DBS
<input type="text"/> <input type="text"/> <input type="text"/>	<input type="text"/> <input type="text"/> <input type="text"/>	<input type="text"/> <input type="text"/> <input type="text"/>	<input type="text"/> <input type="text"/> <input type="text"/>

Component Codes

The Universal Remote Control is capable of operating many component brands after entering a code. Some components may not operate remotely because the codes are not available due to limited memory. The Universal Remote Control does not control all features in all models.

Codes for VCR

Brand	Code
Admiral	200
Aiwa	160
Akai	014, 015, 016, 142
Audio Dynamic	011, 240
Bell & Howell	005, 013
Broksonic	081, 136
Canon	125, 135
Citizen	006
Craig	005, 006, 141
Curtis Mathes	130, 300
Daewoo	001, 130, 250
DBX	010, 011, 140
Dimensia	300
Emerson	003, 080, 081, 135, 136, 243, 250
Fisher	005, 007, 008, 009
Funai	081, 136
GE	130, 170, 300
Goldstar	006
Hitachi	000, 125, 300
Instant Replay	125, 130
Jensen	240
JVC	010, 011, 190, 240
Kenwood	006, 011, 190, 240
LXI	000, 005, 006, 007, 008, 009
Magnavox	125, 130, 150
Marantz	010, 011, 240
Marta	006
Memorex	009, 130
MGA/Mitsubishi	230, 241, 242, 243, 330, 340
Minolta	000, 300
Mitsubishi	230, 241, 242, 243, 330, 340
Multitech	004, 330
NEC	010, 011, 190, 240

Brand	Code
Olympic	125, 130
Optimus	006, 100, 140, 200
Orion	081, 136
Panasonic	100, 101, 125, 130
J.C. Penney	000, 005, 010, 011, 130, 240, 300
Pentax	000, 011, 300
Philco	081, 125, 130, 136, 150
Philips	125, 130, 150
Pioneer	125
Proscan	000, 001, 002, 125, 130, 150, 300, 310
Quasar	100, 101, 125, 130
Radio Shack	005, 009, 130, 170, 210, 241
RCA	000, 001, 002, 125, 130, 150, 170, 300, 310
Realistic	005, 009, 130, 210, 241
Samsung	002, 004, 220
Sansui	051, 081, 136, 240, 520
Sanyo	005, 009
Scott	001, 002, 004, 009, 081, 136, 230, 241, 330, 340
Sears	000, 005, 006, 007, 008
Shintom	050
Sharp	200, 210
Signature 2000	200
Sony	140, 141, 142
Sylvania	125, 130, 150
Tashiro	006
Tatung	010, 011, 240
Teac	010, 011, 240
Technics	100, 101, 125, 130
Teknika	130
Toshiba	001, 310
Vector Research	011
Mont. Wards	006, 009, 200, 210, 290
Yamaha	005, 010, 011, 240
Zenith	290

Codes for Cable Box

Brand	Code
ABC	530
Archer	531, 544
Cableview	005, 544
Citizen	005, 522
Curtis	130, 131
Diamond	530, 531, 544
Eagle	541
Eastern	560
GCBBrand	005, 544
Gemini	522
General Instrument/ Jerrold	122, 360, 520, 521, 522, 530, 531, 532, 533
Hamlin	130, 350, 720, 730, 731, 900
Hitachi	003, 530
Macom	003, 004, 005
Magnavox	535
Memorex	542
Movietime	005, 544
Oak	002, 704, 710
Panasonic	120, 121, 132
Philips	006, 541, 542
Pioneer	001, 260

Brand	Code
Pulsar	005, 544
Puser	544
Realistic	544
Regal	130, 350, 720, 730, 731, 900
Regency	560
Rembrandt	005, 544, 702
Samsung	005
Scientific Atlanta	122, 130, 131
Simark	001, 005
Sprucer	005, 121
Stargate	005, 544
Television	001, 005
Texscan	810
Tocom	700, 701
Toshiba	004
Unika	531, 544
Universal	522, 544
Videoway	006
Viewstar	541, 542
Zenith	000, 280
Zenith/Drake Satellite	000

Codes for Laser Disc

Brand	Code
Panasonic	100, 101, 135, 380
Pioneer	370
Sony	140, 141, 142, 143

Codes for DVD

Brand	Code
Denon	100
Ferguson	110
Nordmende	110
Mitsubishi	150
Panasonic	100
Pioneer	120

Brand	Code
RCA/Proscan	110
Saba	110
Sony	140
Thomson	110
Toshiba	130
Yamaha	100

Codes for DBS

Brand	Code
Echo Star	110
GE	170
Hitachi	411
HNS(Hitachi)	050
Panasonic	100

Brand	Code
Philips	001, 002
RCA	170, 409, 410
Sony	390
Toshiba	000
Uniden	001, 002

Codes for CD

Brand	Code
Admiral	510
Alwa	562, 564
Carver	550
Denon	600
Emerson	572
Fisher	405
Garrard	457
Harman/Kardon	459, 460, 462
Hitachi	407
Jensen	563
JVC	590, 591, 670
Kardon	458
Kenwood	400, 401, 450, 670
LXI/Sears	565
Magnavox	550, 561
Marantz	550
McIntosh	460
Nakamichi	432

Brand	Code
Onkyo	453, 454
Optimus	430, 457, 459, 461
Panasonic	500, 501, 530
Philips	550
Pioneer	430
Quasar	501, 530, 500
RCA	560, 570, 571, 900
Sansui	432, 720
Sanyo	405
Scott	432, 720
Sharp	600, 601
Sherwood	459
Sony	540
Soundesign	620
Teac	451, 455, 457
Technics	500, 501, 530
Victor	590, 591, 670
Yamaha	402, 403, 404

Codes for Cassette Deck

Brand	Code
Aiwa	760, 761, 762
Denon	800
Fisher	603
Jensen	657
JVC	780, 781
Kenwood	600, 650
Marantz	751
Nakamichi	631
Onkyo	651, 652, 656

Brand	Code
Panasonic	700, 730
Philips	751
Pioneer	630
RCA	763, 770, 771
Sansui	631, 653
Sharp	800
Sony	740
Teac	653, 654, 658
Technics	700, 730
Yamaha	601, 602

Codes for Receivers

Brand	Code
Admiral	110
Aiwa	160, 161
Denon	200, 201, 202
Fisher	004
Garrard	055
Harman	050, 157
Jensen	164
JVC	190, 191
Kenwood	000, 050
Magnavox	162
Marantz	151
McIntosh	058
Nakamichi	031
Onkyo	051, 056

Brand	Code
Optimus	003, 162, 170, 171
Panasonic	100, 101, 130
Philips	150
Pioneer	030, 032
Quasar	100, 101, 130
RCA	003, 030, 162, 170, 171
Sansui	003, 053, 320
Sharp	200, 203
Sony	140
Soundesign	220
Teac	053, 054, 055
Technics	100, 101, 130
Victor	190, 191
Yamaha	001, 002

Roller Guide Menu™

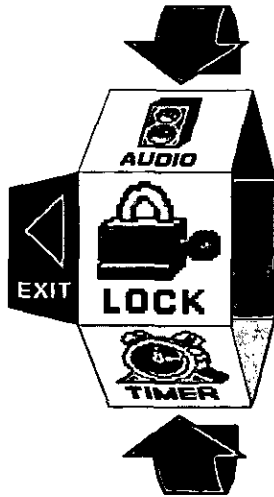

*Rollerguide Trademark

ROLLER GUIDE MENU™ SELECTIONS

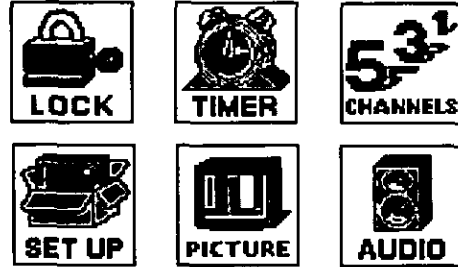

▲▼ FOR MORE FEATURES
PRESS **ACTION** TO SELECT

Basic Navigation

Procedure

- Press the **ACTION** button in the middle of the large blue button on the remote control to display the Roller Guide Menu™.

Note: Be careful to press the **ACTION** button in the middle of the button. If you do not press in the middle of the button, the channel or volume keys may be activated.

- Press the **CH** up/down buttons to rotate the Roller Guide.
- Press the left **VOL** button to exit the Roller Guide Menu™.



Navigation in the Roller Guide

Procedure

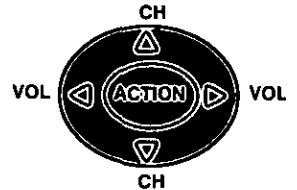

- Press the **ACTION** button to display the selected Icon menus.
- Press the **CH** up/down buttons to select desired menu.
- Press the right **VOL** button to highlight submenus.
- Press the **CH** up/down buttons to highlight desired submenus.
- Press the **VOL** buttons to select and adjust features.
- Press the **ACTION** button repeatedly to exit.





Roller Guide Menu Chart

MENU	DESCRIPTION
	<p>SET UP</p>
<p>IDIOMA/LANUGE (LANGUAGES)</p>	<p><input type="checkbox"/> Select English, Spanish, or French menu.</p>
<p>PROG. CHAN (Program Channels)</p>	<p><input type="checkbox"/> MODE - Select Cable or TV (Antenna). See Installation section in manual.</p> <p><input type="checkbox"/> ANTENNA - Select ANT 1 or ANT 2. See Installation section in manual.</p> <p><input type="checkbox"/> AUTO PROGRAM - Automatically program channels having a signal into memory.</p> <p><input type="checkbox"/> MANUAL PROGRAM - Manually add or delete channels from memory.</p>
<p> CC (Closed Captioned)</p>	<p><input type="checkbox"/> CC ON MUTE - Select C1-C4 for Closed Captioning display when the Remote MUTE button is pressed.</p> <p><input type="checkbox"/> CC MODE - Select OFF, C1, C2, T1, T2, C2, C4, T3, or T4 for transmitted information, if available, in large black box.</p>
<p>OTHER ADJ.</p>	<p><input type="checkbox"/> CONVERGENCE - Adjustment may be required when the PTV is moved because of the effects of the Earth's magnetic field on the projection tubes.</p>
	<p>AUDIO</p>
<p>AUDIO ADJ. (Adjustments)</p>	<p><input type="checkbox"/> MODE - Select STEREO, SAP (Second Audio Program) or MONO. (Use MONO when stereo signal is weak.)</p> <p><input type="checkbox"/> BASS - Increase or decrease the bass response.</p> <p><input type="checkbox"/> TREBLE - Increase or decrease the treble response.</p> <p><input type="checkbox"/> BALANCE - Emphasize the left/right speaker volume.</p> <p><input type="checkbox"/> NORMAL - Reset BASS, TREBLE and BALANCE to factory default.</p>
<p>OTHER ADJ. (Adjustments)</p>	<p><input type="checkbox"/> AI SOUND - Equalize overall volume levels across all programs. (AI sound is not available in VIDEO mode).</p>

Roller Guide Menu Chart (Cont.)

MENU	DESCRIPTION
SURROUND	<input type="checkbox"/> SPATIALIZER® - Three dimensional surround sound with two speakers.
SPEAKERS	<input type="checkbox"/> AUDIO SOURCE <ul style="list-style-type: none"> • TV - speakers operate normally. • EXT & VAO (Variable Audio Output) - TV speakers off - audio adjustable by TV. • EXT & FAO (Fixed Audio Output)- TV speakers off — audio adjustable only by the external amplifier.
	TIMER
CLOCK SET	<input type="checkbox"/> Set the time and the day of the week. (Time will display onscreen after turning the television on, pressing the RECALL button or changing channels).
SLEEP	<input type="checkbox"/> Set timer to turn off TV in 30, 60 or 90 minutes. Select NO to turn timer off.
TIMER 1 TIMER 2	<input type="checkbox"/> Set one or both timers to automatically turn TV on and off at selected times, on selected channels, and on selected days. (Clock must be set to use Timer features.)
	PICTURE
VIDEO ADJ. (Adjustments)	<input type="checkbox"/> COLOR - Adjust desired color intensity. <input type="checkbox"/> TINT - Adjust natural flesh tones. <input type="checkbox"/> BRIGHTNESS - Adjust dark areas for crisp detail. <input type="checkbox"/> PICTURE - Adjust white areas of picture. <input type="checkbox"/> SHARPNESS - Adjust clarity of outline detail. <input type="checkbox"/> NORMAL- Reset all picture adjustments to factory default settings.

Roller Guide Menu Chart (Cont.)

MENU	DESCRIPTION
<p>OTHER ADJ. (Adjustments)</p>	<ul style="list-style-type: none"> <input type="checkbox"/> COLOR TEMP - Adjust white balance to COOL (blue), WARM (red) or NORMAL. <input type="checkbox"/> SCAN MODE - Picture adjustment when switching between video games and DTV picture, if needed. <input type="checkbox"/> COLOR MATRIX - Select HD or SD to automatically adjust color parameters for HD (high definition) and SD (standard definition) transmissions.
	<p style="text-align: center;">CHANNELS</p>
<p>FAVORITES</p>	<ul style="list-style-type: none"> <input type="checkbox"/> CHANNEL SCAN - Select FAV (16 favorites) or ALL channels to scan channels using the up/down CH buttons.
<p>CAPTION</p>	<ul style="list-style-type: none"> <input type="checkbox"/> PRESET CAPTION - Enter channel numbers for preset captions. <input type="checkbox"/> MANUAL CAPTION - Enter channel numbers and captions manually. <input type="checkbox"/> INPUT LABEL - Label video connections for onscreen display of optional equipment.
	<p style="text-align: center;">LOCK</p>
<p>MODE</p>	<ul style="list-style-type: none"> <input type="checkbox"/> Under Mode lock All, Channels or Game with a secret code.
<p>HOW LONG?</p>	<ul style="list-style-type: none"> <input type="checkbox"/> Under HOW LONG select the period of time (12, 24, 48 hours or ALWAYS) for your option to be locked. <p>Note: For more information about Motion Picture Status and TV Parental Guide, see the V-CHIP Parental Lock manual provided with the TV package.</p>

Special Features

SET UP

Menu Languages

In SET UP Menu, select IDIOMA / LANGUE to change menu language to ENGLISH, ESPAÑOL (Spanish) or FRANÇAIS (French).

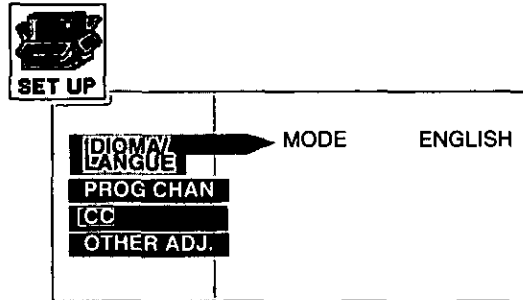

Prog Chan (Program Channels)

In SET UP menu under PROG CHAN select:

- MODE to select TV (antenna) or CABLE mode depending on the signal source.
- ANTENNA to select either ANT1 or ANT2.
- AUTO PROGRAM to automatically program all channels with a signal.
- MANUAL PROGRAM to manually add or delete channels.

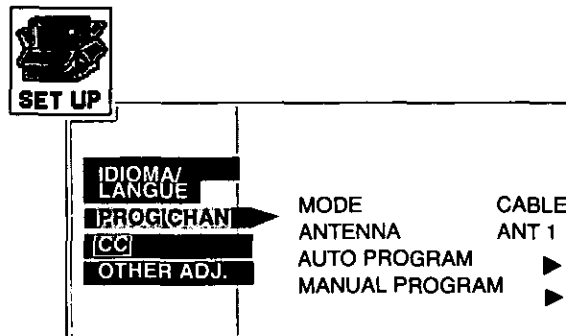

CC (Closed Caption)

This television contains a built-in decoder that displays **CC** (Closed Caption) text across the screen (white or colored letters on black background). It allows the viewer to read the dialogue of a television program or other information. The program viewed must include Closed Captioning for the feature to work.

CC Mode

- In SET UP Menu, select **CC** (Closed Caption).
- Select **CC** MODE.
- Select OFF, C1, C2, T1, T2, C3, C4, T3 or T4:
 - OFF - When Closed Caption is not desired.
 - C1 - For video related information to be displayed, up to 4 lines onscreen at a time. (It does not block relevant parts of the picture). Text may be in any language.
 - C2 to C4 - For other modes of video related information.
 - T1 - For program guide and other information to be displayed, when available. (Blocks a large portion of the picture on the television screen).
 - T2 to T4 - For other modes of information. (Blocks a large portion of the picture on the television screen).
- Press **ACTION** to return to submenu options, and exit menus.

CC On Mute

Activates the onscreen Closed Caption feature when the **MUTE** button on the remote control is pressed. To deactivate press the **MUTE** button again.

Note: This feature only functions when the Closed Caption Mode is OFF. The program being viewed must be broadcast with Closed Captioning. (Refer to your local TV guide).

- In SET UP Menu, select **CC** (Closed Caption).
- Select **CC** ON MUTE
- Select NO, C1, C2, C3, or C4.
- Recommended set up for Closed Caption when using the MUTE button:
 - **CC** ON MUTE: C1
 - **CC** MODE: OFF
- Press **ACTION** to return to submenu options, and exit menus.
- Press the **MUTE** button to activate the Closed Caption feature.
- Press the **MUTE** button again to deactivate the feature.

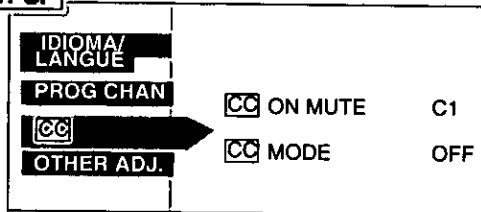

Convergence

In SET UP menu, select CONVERGENCE under OTHER ADJ. only after moving the PTV to adjust for the effects of the earth's magnetic field on the projection tubes. .

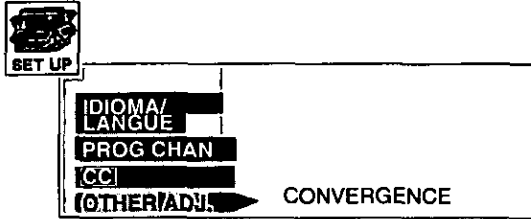

Note: Convergence seldom needs adjusting, except when moving the TV.

Use the navigation buttons to align the horizontal and vertical green lines on screen with the outside reference marks, as shown below. Press the **ACTION** button to move to the RED CONVERGENCE screen.

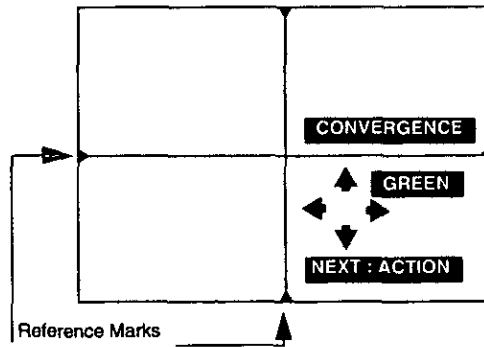

Use the navigation buttons to align the red cross with the white cross pattern at the center of the screen. Press **ACTION** to continue to the blue convergence adjustment screen and repeat.

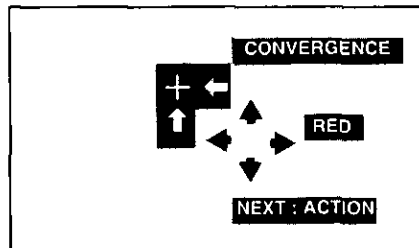

Note: TO PREVENT PICTURE TUBE DAMAGE, DO NOT LEAVE TEST PATTERN ON FOR AN EXTENDED PERIOD OF TIME.

Convergence Adjustment

An adjusted cross pattern appears white with a minimum of color fringing.

TIMER

Sleep

In **TIMER** menu, select **SLEEP** to turn TV off in 30, 60 or 90 minutes. Select **NO** to turn off timer.

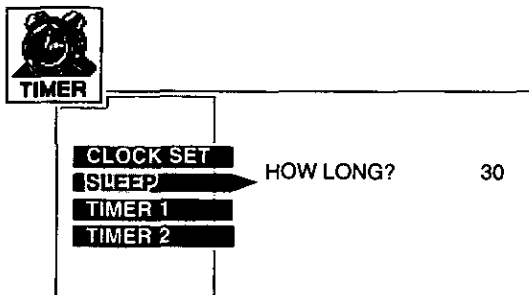

Timer 1 and Timer 2

In **TIMER** menu, select one or both timers to turn the television on and off at selected times, on selected channels, and on selected days.

Note: *TIME must be entered in CLOCK SET to operate TIMER features.*

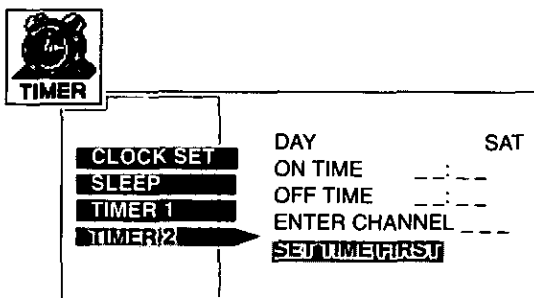

Turn Off After 90 Minutes

The TV automatically turns OFF after 90 minutes when turned on by the **TIMER**. If the **OFF** time is selected or if any key is pressed, the automatic OFF after 90 minutes will be cancelled.



TIMER Activation

The **TIMER** is active when the TV is OFF or ON. The TV will switch to the selected channel at the selected time set in the **TIMER**.

PICTURE

Other Adjustments

In PICTURE menu under OTHER ADJ. select:

- COLOR TEMP (temperature) to increase or decrease WARM (red) and COOL (blue) colors to suit personal preferences.
- SCAN MODE select TV or GAME to do picture adjustment when switching between video games and DTV picture, if needed.
- COLOR MATRIX select HD OR SD to automatically adjust color parameters for HD (high definition) and SD (standard definition) transmissions.

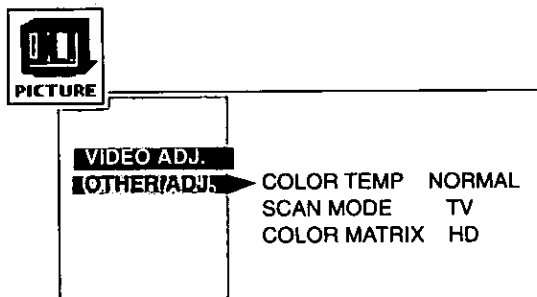

Note: COLOR MATRIX is only adjustable in DTV mode.

AUDIO

Speakers

In AUDIO menu under SPEAKERS, select:

- AUDIO SOURCE - TV for normal TV speakers.
- EXT & VAO (variable audio out) to adjust speakers from TV controls.
- EXT & FAO (fixed audio out) to adjust speakers from an external amplifier.

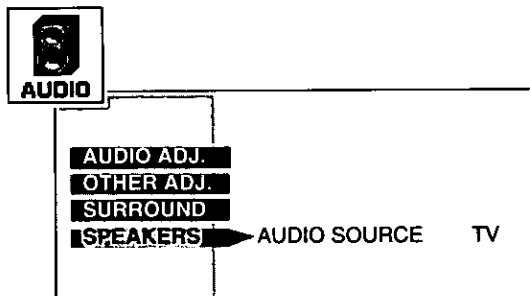

SPECIAL FEATURES

CHANNELS

Favorites

In CHANNELS menu under FAVORITES select:

- CHANNEL SCAN FAV to enter up to 16 favorite channels
- CHANNEL SCAN ALL to scan all channels when using the CH up/down buttons.

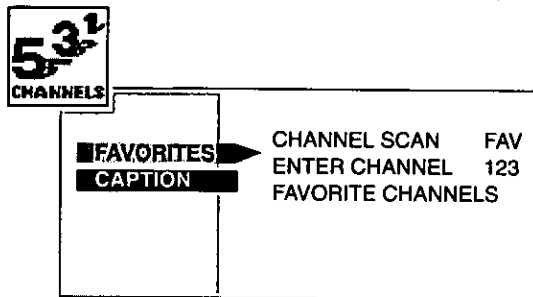

Caption

In CHANNELS menu under CAPTION select:

- PRESET CAPTION to enter channel labels for popular TV stations.
- MANUAL CAPTION to enter numbers and captions manually.
- INPUT LABEL to label video input connections for onscreen display by source (VCR, DVD, etc.).

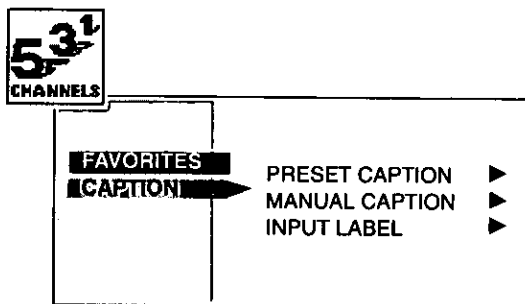

LOCK

Mode

To use LOCK options:

- ENTER CODE FIRST - Use the numeric keypad to enter a four-digit secret code. After entering your secret code for the first time, the onscreen display will change to CHANGE CODE.

Note: Use a code that is easy to remember or record it in a safe place.

In MODE submenu select:

- LOCK SET to choose:
 - OFF - To turn lock function off.
 - ALL - To lock all channels and video inputs.
 - CHANNEL - To lock up to four channels of your choice.
 - GAME - To lock channels 3, 4 and video inputs.
- MOTION PICT[★] - To use Motion Picture Ratings.
- TV PARENTAL[★] - To use TV Parental Guide Ratings.
- CHANGE CODE - Use numeric keypad to change your four-digit secret code.

Note: If in CHANGE CODE you enter a different code from the one used previously, the new code becomes the controlling code.

Press **ACTION** button to return to submenu, then select HOW LONG to choose the period of time you want your option to be locked (12, 24, 48 hours or ALWAYS).

Note: Be cautious when selecting ALWAYS. If ALWAYS is selected, and you forget your secret code, the television must be serviced by a qualified technician in order to clear the LOCK setup.

Press **ACTION** to return to submenu, and to exit menus.

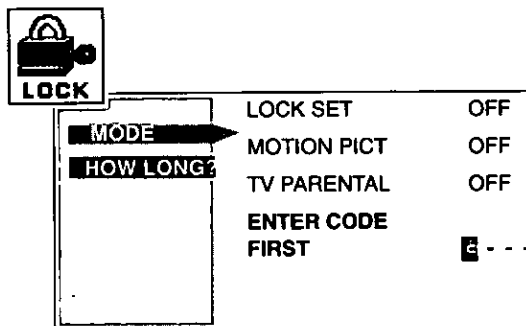

















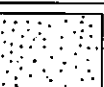

Note: If GAME, CHANNEL or ALL is selected, and if a blocked channel or video input is selected, the message PG (Parent Guard) displays in the upper right corner of the television screen

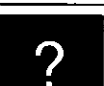
Unlock LOCK SET by reentering the same four-digit secret code and selecting OFF.

[★] For more information about Motion Picture Status and TV Parental Guide, see the V-CHIP Parental Lock manual provided with the TV package.

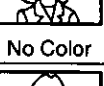
Troubleshooting Chart

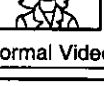
Before calling for service, determine the symptoms and follow suggested solutions.

AUDIO	VIDEO	Solutions
 Noisy Audio	 Snowy Video	Adjust Antenna Location and Connection
 Noisy Audio	 Multiple Image	Adjust Antenna Location and Connection Check Antenna Lead-in Wire
 Noisy Audio	 Interference	Move TV from Electrical Appliances, Lights, Vehicles, and Medical Equipment
 No Audio	 Normal Video	Increase Volume Check Mute Check TV SPEAKERS on/off Change Channel
 Noisy Audio	 No Video	Set TV or Cable Mode Properly Check Antenna Cables
 No Audio	 No Video / No Split Screen	Check Power Cord is Plugged into Active Outlet Adjust Brightness and Audio Controls Change Channel Check Cable Connections Program the Remote Control Again Check Second Video Source Operation
 Normal Audio	 No Color	Adjust Color Settings Change Channel
 Wrong Audio	 Normal Video	Check that Audio is Set to Stereo or Mono, not SAP
 Normal Audio	 Black Box on Screen	Change CC (Closed Captioning) from Text Mode
 Normal Audio	 Normal Video	Replace Remote Control Batteries
Intermittent Remote Control Operation		

